



# Handheld Thermal Monocular Camera

User Manual

## Legal Information

©2022 Hangzhou Microimage Software Co., Ltd. All rights reserved.

### About this Manual

The Manual includes instructions for using and managing the Product. Pictures, charts, images and all other information hereinafter are for description and explanation only. The information contained in the Manual is subject to change, without notice, due to firmware updates or other reasons. Please find the latest version of this Manual at the HIKMICRO website ([www.hikmicrotech.com/](http://www.hikmicrotech.com/)).

Please use this Manual with the guidance and assistance of professionals trained in supporting the Product.

### Trademarks Acknowledgement



HIKMICRO and other HIKMICRO's trademarks and logos are the properties of

HIKMICRO in various jurisdictions.

Other trademarks and logos mentioned are the properties of their respective owners.

### LEGAL DISCLAIMER

TO THE MAXIMUM EXTENT PERMITTED BY APPLICABLE LAW, THIS MANUAL AND THE PRODUCT DESCRIBED, WITH ITS HARDWARE, SOFTWARE AND FIRMWARE, ARE PROVIDED "AS IS" AND "WITH ALL FAULTS AND ERRORS". HIKMICRO MAKES NO WARRANTIES, EXPRESS OR IMPLIED, INCLUDING WITHOUT LIMITATION, MERCHANTABILITY, SATISFACTORY QUALITY, OR FITNESS FOR A PARTICULAR PURPOSE. THE USE OF THE PRODUCT BY YOU IS AT YOUR OWN RISK. IN NO EVENT WILL HIKMICRO BE LIABLE TO YOU FOR ANY SPECIAL, CONSEQUENTIAL, INCIDENTAL, OR INDIRECT DAMAGES, INCLUDING, AMONG OTHERS, DAMAGES FOR LOSS OF BUSINESS PROFITS, BUSINESS INTERRUPTION, OR LOSS OF DATA, CORRUPTION OF SYSTEMS, OR LOSS OF DOCUMENTATION, WHETHER BASED ON BREACH OF CONTRACT, TORT (INCLUDING NEGLIGENCE), PRODUCT LIABILITY, OR OTHERWISE, IN CONNECTION WITH THE USE OF THE PRODUCT, EVEN IF HIKMICRO HAS BEEN ADVISED OF THE POSSIBILITY OF SUCH DAMAGES OR LOSS.

YOU ACKNOWLEDGE THAT THE NATURE OF THE INTERNET PROVIDES FOR INHERENT SECURITY RISKS, AND HIKMICRO SHALL NOT TAKE ANY RESPONSIBILITIES FOR ABNORMAL OPERATION, PRIVACY LEAKAGE OR OTHER DAMAGES RESULTING FROM CYBER-ATTACK, HACKER ATTACK, VIRUS INFECTION, OR OTHER INTERNET SECURITY RISKS; HOWEVER, HIKMICRO WILL PROVIDE TIMELY TECHNICAL SUPPORT IF REQUIRED.

YOU AGREE TO USE THIS PRODUCT IN COMPLIANCE WITH ALL APPLICABLE LAWS, AND YOU ARE SOLELY RESPONSIBLE FOR ENSURING THAT YOUR USE CONFORMS TO THE APPLICABLE LAW. ESPECIALLY, YOU ARE RESPONSIBLE, FOR USING THIS PRODUCT IN A MANNER THAT DOES NOT INFRINGE ON THE RIGHTS OF THIRD PARTIES, INCLUDING WITHOUT LIMITATION, RIGHTS OF PUBLICITY, INTELLECTUAL PROPERTY RIGHTS, OR DATA PROTECTION AND OTHER PRIVACY RIGHTS. YOU SHALL NOT USE THIS PRODUCT FOR ILLEGAL HUNTING ANIMALS, INVASION OF PRIVACY OR ANY OTHER PURPOSE WHICH IS ILLEGAL OR DETRIMENTAL TO THE PUBLIC INTEREST. YOU SHALL NOT USE THIS PRODUCT FOR ANY PROHIBITED END-USES, INCLUDING THE DEVELOPMENT OR PRODUCTION OF WEAPONS OF MASS DESTRUCTION, THE DEVELOPMENT OR PRODUCTION OF

## Handheld Thermal Monocular Camera User Manual

---

CHEMICAL OR BIOLOGICAL WEAPONS, ANY ACTIVITIES IN THE CONTEXT RELATED TO ANY NUCLEAR EXPLOSIVE OR UNSAFE NUCLEAR FUEL-CYCLE, OR IN SUPPORT OF HUMAN RIGHTS ABUSES.

IN THE EVENT OF ANY CONFLICTS BETWEEN THIS MANUAL AND THE APPLICABLE LAW, THE LATTER PREVAILS.

## Regulatory Information

### FCC Information

Note: This product has been tested and found to comply with the limits for a Class B digital device, pursuant to Part 15 of the FCC Rules. These limits are designed to provide reasonable protection against harmful interference in a residential installation. This product generates, uses, and can radiate radio frequency energy and, if not installed and used in accordance with the instructions, may cause harmful interference to radio communications. However, there is no guarantee that interference will not occur in a particular installation. If this product does cause harmful interference to radio or television reception, which can be determined by turning the equipment off and on, the user is encouraged to try to correct the interference by one or more of the following measures:

- Reorient or relocate the receiving antenna.
- Increase the separation between the equipment and receiver.
- Connect the equipment into an outlet on a circuit different from that to which the receiver is connected.
- Consult the dealer or an experienced radio/TV technician for help.

Please take attention that changes or modification not expressly approved by the party responsible for compliance could void the user's authority to operate the equipment. This device complies with Part 15 of the FCC Rules. Operation is subject to the following two conditions:

- (1) This device may not cause harmful interference, and
- (2) This device must accept any interference received, including interference that may cause undesired operation.

This equipment complies with FCC radiation exposure limits set forth for an uncontrolled environment.

### EU Conformity Statement



This product and - if applicable - the supplied accessories too are marked with "CE" and comply therefore with the applicable harmonized European standards listed under the Directive 2014/53/EU(RED), Directive 2014/30/EU(EMCD), Directive 2014/35/EU(LVD), Directive 2011/65/EU(RoHS).



Directive 2012/19/EU (WEEE Directive): Products marked with this symbol cannot be disposed of as unsorted municipal waste in the European Union. For proper recycling, return this product to your local supplier upon the purchase of equivalent new equipment, or dispose of it at designated collection points. For more information see: [www.recyclethis.info](http://www.recyclethis.info)



Directive 2006/66/EC and its amendment 2013/56/EU (Battery Directive): This product contains a battery that cannot be disposed of as unsorted municipal waste in the European Union. See the product documentation for specific battery information. The battery is marked with this symbol, which may include lettering to indicate cadmium (Cd), lead (Pb), or mercury (Hg). For proper recycling, return the battery to your supplier or to a designated collection point. For more information see: [www.recyclethis.info](http://www.recyclethis.info).

### Industry Canada ICES-003 Compliance

This device meets the CAN ICES-3 (B)/NMB-3(B) standards requirements.

This device complies with Industry Canada license-exempt RSS standard(s). Operation is subject to the following two conditions:

- (1) this device may not cause interference, and
- (2) this device must accept any interference, including interference that may cause undesired operation of the device.

Le présent appareil est conforme aux CNR d'Industrie Canada applicables aux appareils radioexempts de licence. L'exploitation est autorisée aux deux conditions suivantes :

- (1) l'appareil ne doit pas produire de brouillage, et
- (2) l'utilisateur de l'appareil doit accepter tout brouillage radioélectrique subi, même si le brouillage est susceptible d'en compromettre le fonctionnement.

This equipment complies with IC RSS-102 radiation exposure limits set forth for an uncontrolled environment.



ce matériel est conforme aux limites de dose d'exposition aux rayonnements, CNR-102 énoncée dans un autre environnement.

### KC

B급 기기: 이 기기는 가정용 (B급) 전자파적합기기로서 주로 가정에서 사용하는 것을 목적으로 하며, 모든 지역에서 사용할 수 있습니다.

## Symbol Conventions

The symbols that may be found in this document are defined as follows.

Symbol	Description
 <b>Danger</b>	Indicates a hazardous situation which, if not avoided, will or could result in death or serious injury.
 <b>Caution</b>	Indicates a potentially hazardous situation which, if not avoided, could result in equipment damage, data loss, performance degradation, or unexpected results.
 <b>Note</b>	Provides additional information to emphasize or supplement important points of the main text.

## Safety Instruction

These instructions are intended to ensure that user can use the product correctly to avoid danger or property loss.

### Laws and Regulations

- Use of the product must be in strict compliance with the local electrical safety regulations.

### Transportation

- Keep the device in original or similar packaging while transporting it.
- Keep all wrappers after unpacking them for future use. In case of any failure occurred, you need to return the device to the factory with the original wrapper. Transportation without the original wrapper may result in damage on the device and the company shall not take any responsibilities.
- Do not drop the product or subject it to physical shock. Keep the device away from magnetic interference.

### Power Supply

- Input voltage should meet the Limited Power Source (5 VDC, 2 A) according to the IEC62368-1 standard. Please refer to technical specifications for detailed information.
- Make sure the plug is properly connected to the power socket.
- DO NOT connect multiple devices to one power adapter, to avoid over-heating or fire hazards caused by overload.
- Use the power adapter provided by qualified manufacturer. Refer to the product specification for detailed power requirements.

### Battery

- The built-in battery cannot be dismantled. Please contact the manufacture for repair if necessary.
- For long-term storage of the battery, make sure it is fully charged every half year to ensure the battery quality. Otherwise, damage may occur.
- Use the battery provided by qualified manufacturer. Refer to the product specification for detailed battery requirements.
- CAUTION: Risk of explosion if the battery is replaced by an incorrect type.
- Improper replacement of the battery with an incorrect type may defeat a safeguard (for example, in the case of some lithium battery types).
- Do not dispose of the battery into fire or a hot oven, or mechanically crush or cut the battery, which may result in an explosion.
- Do not leave the battery in an extremely high temperature surrounding **environment**, which may result in an explosion or the leakage of flammable liquid or gas.
- Do not subject the battery to extremely low air pressure, which may result in an explosion or the leakage of flammable liquid or gas.

- Dispose of used batteries according to the instructions.

### **Maintenance**

- If the product does not work properly, please contact your dealer or the nearest service center. We shall not assume any responsibility for problems caused by unauthorized repair or maintenance.
- Wipe the device gently with a clean cloth and a small quantity of ethanol, if necessary.
- If the equipment is used in a manner not specified by the manufacturer, the protection provided by the device may be impaired.

### **Using Environment**

- Make sure the running environment meets the requirement of the device. The operating temperature shall be -30°C to 55°C (-22°F to 131°F), and the operating humidity shall be 95% or less.
- DO NOT expose the device to high electromagnetic radiation or dusty environments.
- DO NOT aim the lens at the sun or any other bright light.

### **Maintenance**

- If the product does not work properly, please contact your dealer or the nearest service center. We shall not assume any responsibility for problems caused by unauthorized repair or maintenance.
- Wipe the device gently with a clean cloth and a small quantity of ethanol, if necessary.
- If the equipment is used in a manner not specified by the manufacturer, the protection provided by the device may be impaired.

### **Using Environment**

- Make sure the running environment meets the requirement of the device. The operating temperature shall be -20°C to 55°C (-4°F to 131°F), and the operating humidity shall be 95% or less.
- DO NOT expose the device to high electromagnetic radiation or dusty environments.
- DO NOT aim the lens at the sun or any other bright light.

### **Emergency**

- If smoke, odor, or noise arises from the device, immediately turn off the power, unplug the power cable, and contact the service center.

### **Manufacture Address**

Room 313, Unit B, Building 2, 399 Danfeng Road, Xixing Subdistrict, Binjiang District, Hangzhou, Zhejiang 310052, China  
Hangzhou Microimage Software Co., Ltd.

COMPLIANCE NOTICE: The thermal series products might be subject to export controls in various countries or regions, including without limitation, the United States, European Union, United Kingdom and/or other member countries of the Wassenaar Arrangement. Please consult your



## Handheld Thermal Monocular Camera User Manual

---

professional legal or compliance expert or local government authorities for any necessary export license requirements if you intend to transfer, export, re-export the thermal series products between different countries.

## Table of Contents

<b>Chapter 1 Overview .....</b>	<b>1</b>
<b>1.1 Brief Description .....</b>	<b>1</b>
<b>1.2 Function .....</b>	<b>1</b>
<b>1.3 Appearance .....</b>	<b>2</b>
<b>1.3.1 Button .....</b>	<b>2</b>
<b>1.3.2 Interface .....</b>	<b>3</b>
<b>Chapter 2 Preparation .....</b>	<b>4</b>
<b>2.1 Charge Device .....</b>	<b>4</b>
<b>2.2 Power On/Off .....</b>	<b>4</b>
<b>2.3 Menu Description .....</b>	<b>5</b>
<b>Chapter 3 Image Settings .....</b>	<b>6</b>
<b>3.1 Adjust Diopter .....</b>	<b>6</b>
<b>3.2 Adjust Focus .....</b>	<b>7</b>
<b>3.3 Adjust Brightness .....</b>	<b>8</b>
<b>3.4 Adjust Contrast .....</b>	<b>8</b>
<b>3.5 Select Scene .....</b>	<b>8</b>
<b>3.6 Set Palettes .....</b>	<b>8</b>
<b>3.7 Adjust Digital Zoom .....</b>	<b>10</b>
<b>3.8 Flat Field Correction .....</b>	<b>10</b>
<b>3.9 Correct Defective Pixel .....</b>	<b>11</b>
<b>3.10 Brand Logo .....</b>	<b>12</b>
<b>3.11 Set OSD .....</b>	<b>12</b>
<b>3.11.1 Synchronize Time .....</b>	<b>12</b>
<b>Chapter 4 Measure Distance .....</b>	<b>1</b>
<b>Chapter 5 Burning Prevention .....</b>	<b>2</b>
<b>Chapter 6 Hot Tracking .....</b>	<b>3</b>
<b>Chapter 7 Picture and Video .....</b>	<b>4</b>
<b>7.1 Capture Picture .....</b>	<b>4</b>
<b>7.2 Record Video .....</b>	<b>4</b>
<b>7.3 Export Files .....</b>	<b>5</b>

---

<b>Chapter 8 Client Software Connection .....</b>	<b>6</b>
<b>Chapter 9 CVBS Output .....</b>	<b>7</b>
<b>Chapter 10 Language Settings .....</b>	<b>8</b>
<b>Chapter 11 Unit Settings .....</b>	<b>9</b>
<b>Chapter 12 Maintenance .....</b>	<b>10</b>
<b>12.1 View Device Information .....</b>	<b>10</b>
<b>12.2 Upgrade Device .....</b>	<b>10</b>
<b>12.3 Restore Device .....</b>	<b>10</b>
<b>Chapter 13 Frequently Asked Questions .....</b>	<b>11</b>
<b>13.1 Why does the charge indicator flash improperly? .....</b>	<b>11</b>
<b>13.2 Why is the power indicator off? .....</b>	<b>11</b>
<b>13.3 The image is not clear, how to adjust it? .....</b>	<b>11</b>
<b>13.4 Capturing or recording fails. What's the problem? .....</b>	<b>11</b>
<b>13.5 Why the PC cannot identify the device? .....</b>	<b>11</b>
<b>Chapter 14 Appendix .....</b>	<b>12</b>
<b>14.1 Device Command .....</b>	<b>12</b>
<b>14.2 Device Communication Matrix .....</b>	<b>12</b>

---

# Chapter 1 Overview

## 1.1 Brief Description

The handheld thermal monocular camera is a handheld device with functions of observation, highest temperature target tracking, distance measurement, Wi-Fi hotspot, and so on. The high-sensitivity built-in thermal detector provides you with clear view even in total darkness. The device is mainly applied to outdoor scenarios such as hunting, searching and rescuing, hiking, and travel.

## 1.2 Function

### Distance Measurement

The device can detect the distance between the target and the observation position.

### Hot Tracking

The device can detect the highest temperature in the scene and mark the spot. This function varies according to different camera models.

### Image Correction

The device supports DPC (Defective Pixel Correction) and FFC (Flat Field Correction) which can optimize the image quality.

### Client Software Connection

The device can capture snapshots, record videos, and set parameters by HIKMICRO Sight App after being connected to your phone via hotspot.

### Storage

The built-in memory module supports video recording and snapshot capturing.

## 1.3 Appearance

### 1.3.1 Button

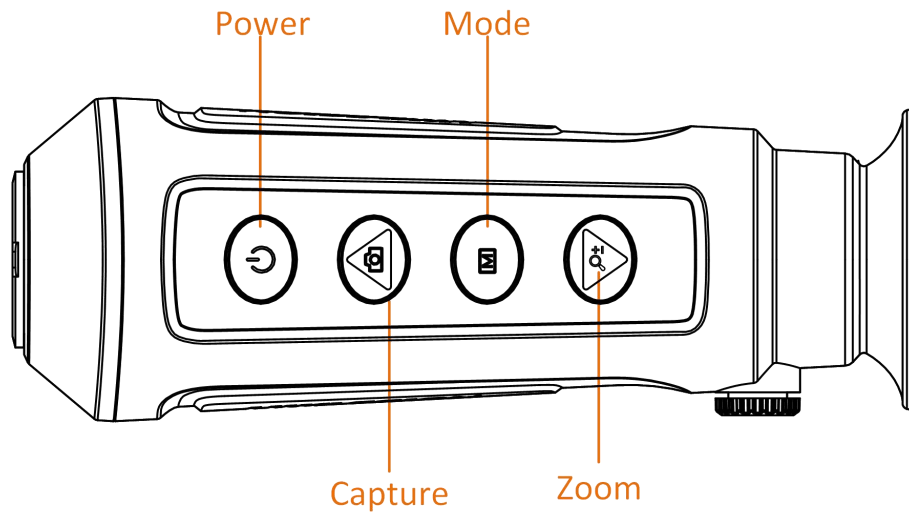



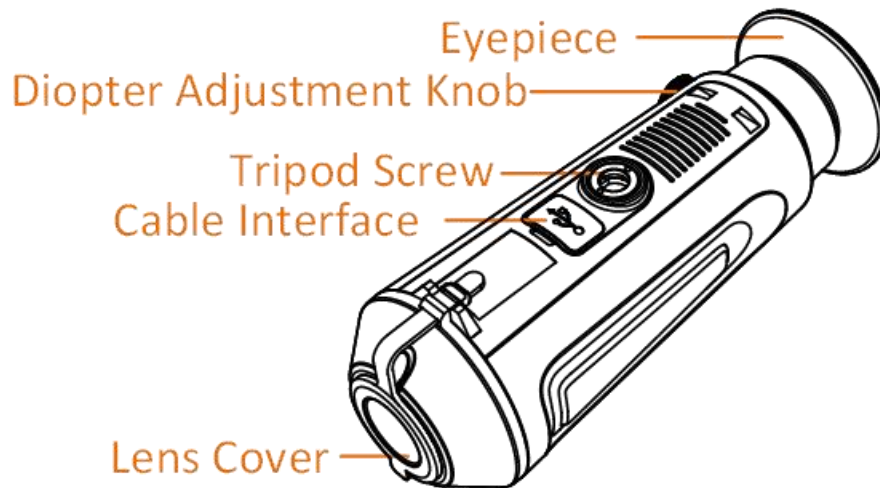

Figure 1-1 Buttons on the Device

Table 1-1 Function of Button

Icon	Button	Function
	Power	Press: standby mode/wake up device Hold: power on/off
	Capture	Press: capture Hold: recording
	Mode	Press: palettes Hold: menu
	Zoom	Press: digital zoom Hold: FFC

### 1.3.2 Interface



**Figure 1-2 Overview of Interfaces**

- Lens Cover: protect the lens from dust or scratch.
- Diopter Adjustment Knob: adjust the view according to your degree of myopia.
- Cable Interface: charge the device or export files with the supplied cable.
- Tripod Screw: connected to tripod.

## Chapter 2 Preparation

Take out the device and accessories. Check them with the packaging list to confirm device and accessories are included and available for use. Read the user manual to learn the usage methods and cautions.

### 2.1 Charge Device

After the device starts up, the OSD (on-screen display) shows the battery status. When the battery is low, charge the device and ensure it works properly.

#### Before You Start

- The charging temperature should be from 0 °C to 45 °C (32 °F to 113 °F).
- Charge the device with the delivered cable.

#### Steps

1. Lift the cable interface cover.
2. Plug in the cable and charge the device.

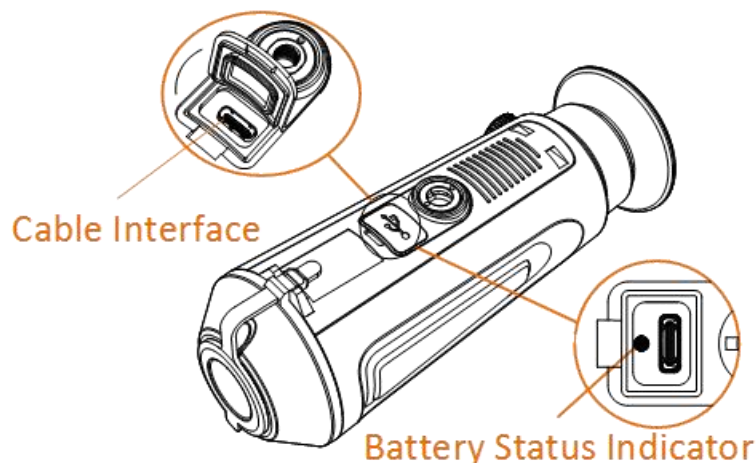



Figure 2-1 Cable Interface

- Flashing Red & Green: error occurred.
- Solid Red: battery is properly charged.
- Solid Green: battery is fully charged.
- Off: battery is not charged.

### 2.2 Power On/Off

#### Power On

When the device is connected to cable or the battery is enough, hold  for 2 seconds to power on the device.





## Power Off

When the device is turned on, hold  for 2 seconds to power off the device.

## Auto Power Off



You can set the auto power off time for your device.

### Steps

1. Hold  to go to the menu.
2. Select , and press  to select the auto power off time as required.
3. Hold  to save and exit.

---

### Note

- See the battery icon for the battery status.  means the battery is fully charged, and  means that the battery is low.
  - When the low power note shows, charge the battery.
  - The auto power off countdown will start again when the device exits standby mode or the device is restarted.
- 

## 2.3 Menu Description

When the device powers on, hold  to display the menu.

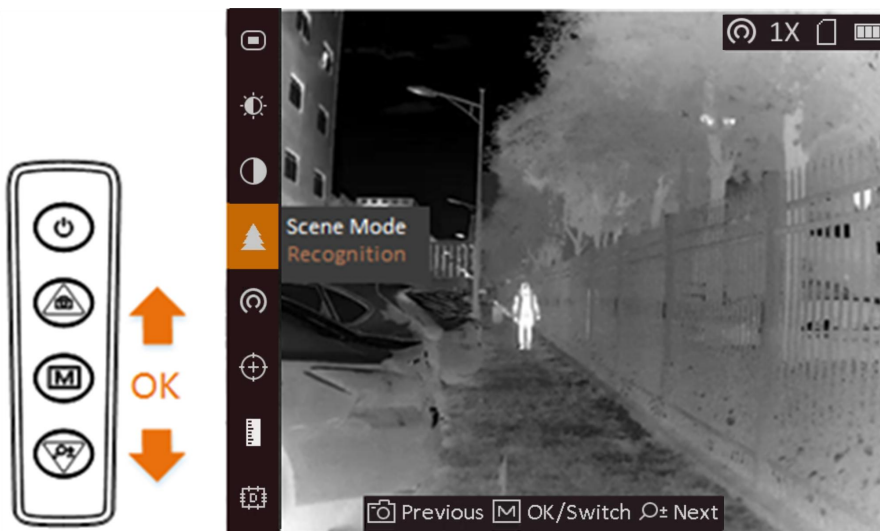





Figure 2-2 Menu Description

- Press  to move the cursor up.
- Press  to move the cursor down.
- Press  to confirm and hold it to exit the menu.



## Chapter 3 Image Settings

You can set palettes, brightness, scenes, FFC (flat field correction), and DPC (defective pixel correction) to display the best image effect.

### 3.1 Adjust Diopter

Make sure the eyepiece covers your eye and aim at the target. Adjust the diopter adjustment knob until the OSD text or image is clear.

---

 **Note**

When adjusting diopter, DO NOT touch the surface of lens to avoid smearing the lens.

---

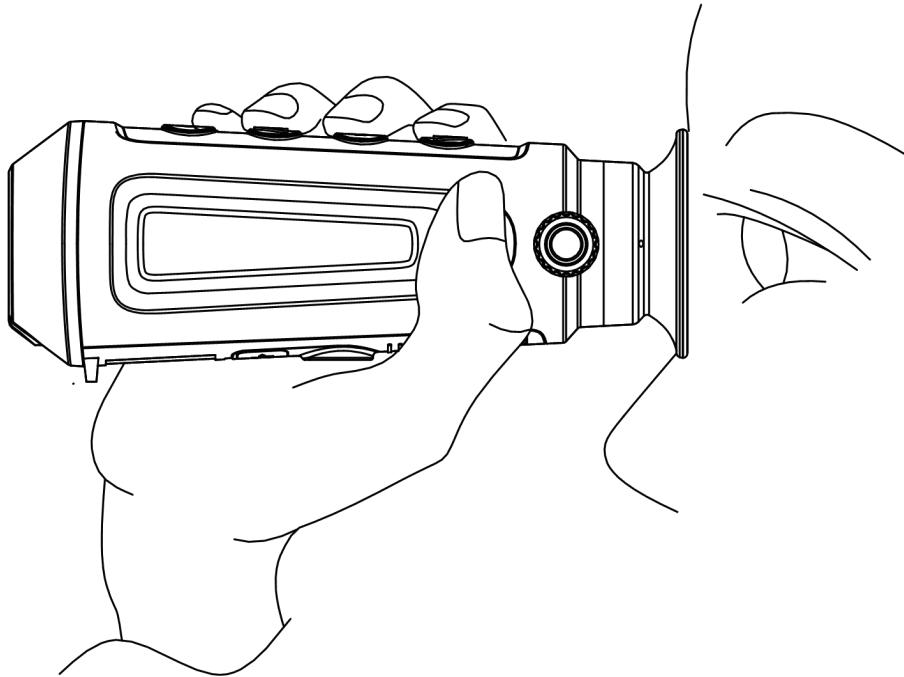

**Figure 3-1 View the Target**

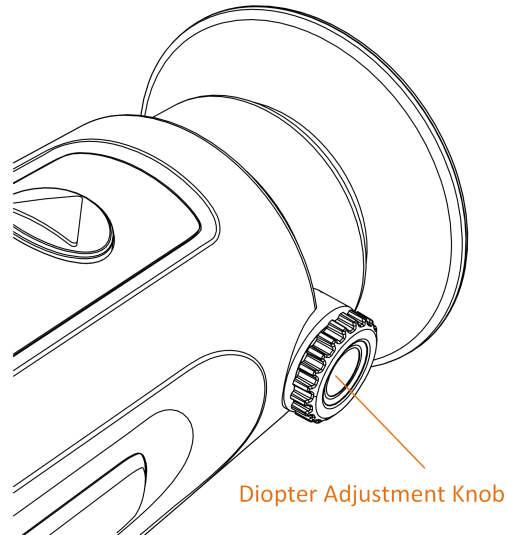

**Figure 3-2 Adjust Diopter**

## 3.2 Adjust Focus

Slightly rotate the focus wheel to adjust the focus of the objective lens.

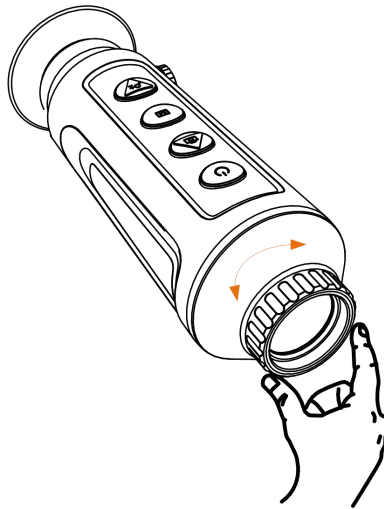

**Figure 3-3 Adjust Objective Lens**

---

### Note

- DO NOT touch the lens directly with your finger, or place any sharp objects near them.
  - This function varies according to different camera models.
-

### 3.3 Adjust Brightness



Select  and press  to adjust brightness. In white hot mode, the higher the value of brightness is, the brighter the image is. The image effect in white hot mode is showed as picture below and effect in black hot mode is opposite.



Figure 3-4 Adjust Brightness in White Hot Mode







### 3.4 Adjust Contrast

Select  and press  to adjust image contrast.

### 3.5 Select Scene

You can select proper scene according to actual using scene to improve the display effect.

#### Steps

1. Hold  to go to the menu.
2. Select  and press  to switch scene.
  -  refers to recognition mode and is recommended in normal scene.
  -  refers to jungle mode and is recommended in hunting environment.
3. Hold  to save settings and exit.

### 3.6 Set Palettes

You can select different palettes to display the same scene in different effects. Press  to switch palettes.

#### White Hot

The hot part is light-colored in view. The higher the temperature is, the lighter the color is.

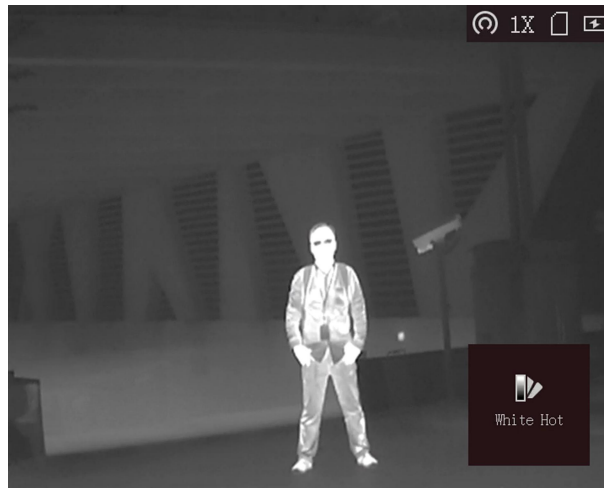

## Black Hot

The hot part is black-colored in view. The higher the temperature is, the darker the color is.

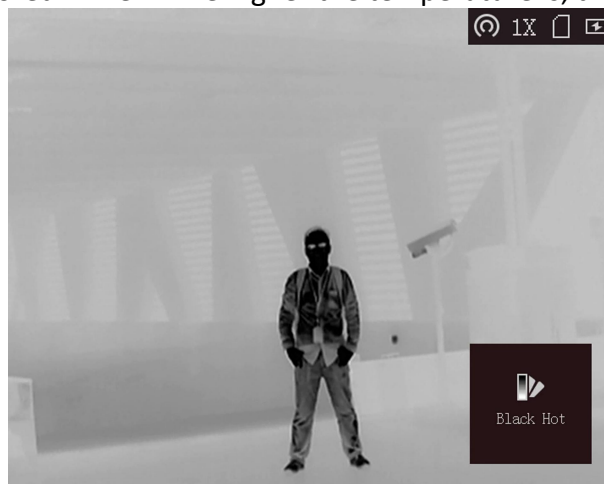

## Red Hot

The hot part is red-colored in view. The higher the temperature is, the redder the color is.

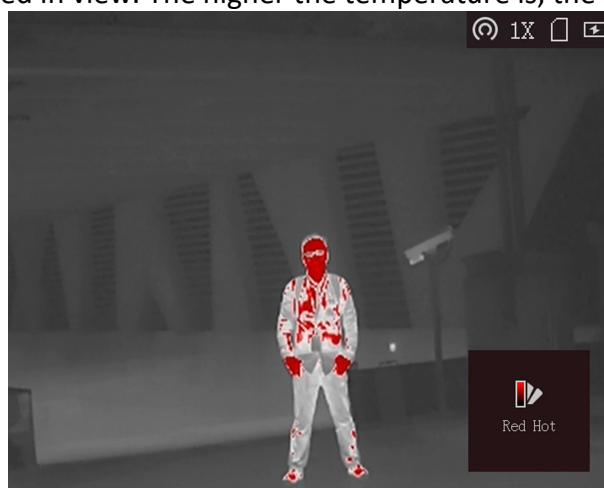

## Fusion

From high temperature to low temperature, the image is colored in from white, yellow, red, pink to purple.



### 3.7 Adjust Digital Zoom

You can zoom the image by using this function.

Press  in the view mode, the live view switches between 1 x, 2 x, 4 x and 8 x.

---

#### Note







This function varies according to different camera models.

---

### 3.8 Flat Field Correction

This function can correct non-uniformity of display.

#### Steps

1. Hold  to go to the menu.
2. Select  and press  to switch FFC mode.
  - Manual: Hold  in live view to correct the non-uniformity of display.
  - Auto: The device performs FFC automatically according to the set schedule when switching on the camera.
  - External: Cover the lens cover, then hold  in live view to correct the non-uniformity of display.
3. Hold  to save the settings and exit.

### 3.9 Correct Defective Pixel

The device can correct the defective pixels on the screen which are not performed as expected.

#### Steps

1. Hold **[M]** to show the menu.
2. Select **[D]** and press **[M]** to enter the DPC setting interface.
3. On the DPC setting interface, press **[M]** to select **Axis**, and press **[M]** to switch the moving direction of the cursor. If you select **X**, the cursor moves left and right; if you select **Y**, the cursor moves up and down.
4. Press **[C]** or **[Z]** to move the cursor until it reaches the defective pixel, and press **[M]** to select **Axis** to **N**.
5. Press **[C]** or **[Z]** to select DPC, and press **[M]** correct the defective pixel.
6. Hold **[M]** to exit.

#### Note

- The selected defective pixel can be magnified and displayed at the bottom right of the interface.



Figure 3-5 Correct Defective Pixel

- If the screen OSD blocks the defective pixel, move the cursor to reach the defective pixel, then the device performs mirror display automatically as shown in the figures below.

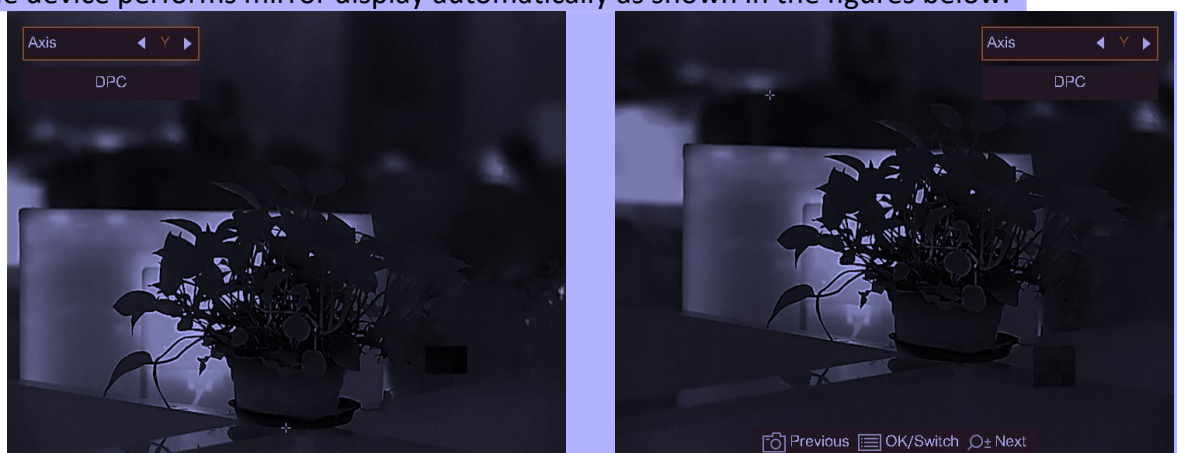





Figure 3-6 Mirror Effect

## 3.10 Brand Logo

You can add brand logo on the live view interface, captures, and videos.

### Steps

1. Hold  to show the menu.
2. Select .
3. Press  to enable **Brand Logo**.
4. Hold  to save the settings and exit.

### Result

The brand logo is displayed at the bottom right of the image.









Figure 3-7 Brand Logo Display

## 3.11 Set OSD



This function can display or hide the ODS information on the live view interface.







### Steps

1. Hold  to show the menu.
2. Select , and press  to enter the OSD setting interface.
3. Press  or  to select the OSD information you want to display or hide.
4. Press  to enable or disable the selected OSD information.

### 3.11.1 Synchronize Time

#### Steps

1. Hold  to show the menu.
2. Select , and press  to enter the time setting interface.

3. Press  to switch the time system, and press  and  to select the time and date to be synchronized.
4. Press  to select the hour, minute, second, year, month, or day to be synchronized, and press  and  to change the number.
5. Hold  to save settings and exit.



## Chapter 4 Measure Distance

The device can detect the distance between the target and the observation position.

### Before You Start

When measuring the distance, keep the hand and the position steady. Otherwise, the accuracy may be affected.

### Steps

1. Hold **[M]** to show the menu.
2. Select **[I]** and press **[M]** to go to the setting interface.
  - 1) Press **[C]** or **[Z]** to select the target from **Deer**, **Grey Wolf**, **Brown Bear**, and **Custom**.
  - 2) Set the target height.

---

### **[i]**Note

The available height ranges from 0.1 m to 9.9 m.

---

- 3) Press **[M]** to confirm.
3. Align the center of top mark with the edge of target top. Press **[M]**.

The cursor blinks on the top edge of the target.
4. Align the center of bottom mark with the edge of target bottom. Press **[M]**.

### Result

The left top of the image displays the distance measurement result and the height of the target.



Figure 4-1 Measurement Result

---

### **[i]**Note



Go to distance measurement interface, and press **[M]** to view the result of the previous measuring target.

---

## Chapter 5 Burning Prevention

This function can prevent the detector of the thermal channel from being burned. When this function is enabled, the shield will close if the grey scale of the detector reaches a certain value.

### Steps

1. Hold  to show the menu.
2. Select , and press  to enable or disable the burn-prevention function.

---

### Note



When the burn-prevention function is disabled, the shield should be opened if it closes.

---

## Chapter 6 Hot Tracking

The device can detect the highest temperature spot in the scene and mark it on display.

### Steps

1. Hold  to show the menu.
2. Select , and press  to mark the spot of highest temperature.

### Result



When the function is enabled,  displays in the spot of highest temperature. When the scene changes, the  moves.



Figure 6-1 Hot Tracking

---

### Note

This function varies according to different camera models.

---

## Chapter 7 Picture and Video

You can manually record video or capture picture when displaying live view.

### 7.1 Capture Picture

On the main live view page, press  to capture picture.

---

#### Note

When capturing succeeds, the image freezes for 1 second and a prompt shows on the display. For exporting captured pictures, refer to ***Export Files***.

---

### 7.2 Record Video

#### Steps

1. In the main live view, hold  and start recording.



**Figure 6-1 Start Recording**

The left top of image displays the information of recording time.

2. Hold  again to stop recording.

#### What to do next

For exporting recording files, refer to ***Export Files***.

## 7.3 Export Files

This function is used to export recorded videos and captured pictures.

### Before You Start

Turn off hotspot function.

### Steps

1. Connect the device and PC with cable.

---

 **Note**

Make sure the device is turned on when connecting the cable.

---

2. Open computer disk and select the disk of device. Go to the DCIM folder and find the folder named after the capture year and month. For example, if you capture a picture or record a video on June 2021, go to **DCIM** → **202106** to find the picture or video.
3. Select and copy the files to PC.
4. Disconnect the device from your PC.

---



 **Note**

- The device displays images when you connect it to PC. But functions such as recording, capturing and hotspot are disabled.
  - When you connect the device to PC for the first time, it installs the drive program automatically.
  - You can also use the HIKMICRO Sight App to export files.
-

## Chapter 8 Client Software Connection

Connect the device to the HIKMICRO Sight App via hotspot, then you can capture picture, record video, or configure parameters on your phone.

### Steps

1. Hold  to show the menu of device.
2. Press  to enable hotspot function.
3. Turn on the WLAN of your phone and connect to the hotspot.
  - Hotspot Name: HIK-IPTS Serial No.
  - Hotspot Password: **Serial No.**
4. Search the HIKMICRO Sight on App Store (iOS System) or Google Play™ (Android System) to download it, or scan the QR code to download and install the app.



Android System



iOS System

5. Open the App and connect your phone with the device. You can view the interface of device on your phone.

---

### Note

- The device cannot connect to the App if you enter wrong password several times. Refer to **Restore Device** to reset the device, and connect the App again.
  - The device should be activated for the first use. The default password must be changed after the activation.
-



## Chapter 9 CVBS Output

The CVBS output is used to debug the device. You can also view the device image on the display unit for details.

### Before You Start

Connect the device and the display unit via USB to CVBS cable. Make sure the device is turned off when connecting the cable.

### Steps

1. Hold  to show the menu of device.
2. Select , and press  to turn on CVBS output.  
The display unit show the device image.

---

### Note







The CVBS cable is not included in the package. Please purchase it by yourself.

---

## Chapter 10 Language Settings

You can select the device language in this function.

### Steps





1. Hold  to show the menu.
2. Select , and press  to enter the language configuration interface.
3. Press  or  to select the language as required, and press  to confirm.



## Chapter 11 Unit Settings

You can switch the unit for distance measurement.

### Steps



1. Hold  to show the menu.
2. Select , and press  to enter the unit setting interface.
3. Press  to switch the unit as required.
4. Hold  to save settings and exit.

## Chapter 12 Maintenance

This part introduces the operation of checking device information, upgrading device, and restoring to defaults, etc.

### 12.1 View Device Information

#### Steps

1. Hold  to show the menu of device.
2. Select , and press . You can view the device information such as version, and serial No.

### 12.2 Upgrade Device

#### Before You Start

Please get the upgrade package first.

#### Steps



1. Connect the device to your PC with cable.
2. Open the detected disk, copy the upgrade file and paste it to the root directory of the device.
3. Disconnect the device from your PC.
4. Reboot the device.

#### Result

The device upgrades automatically. The upgrading process will be displayed in the main interface.

### 12.3 Restore Device

#### Steps

1. Hold  to show the menu of device.
2. Select , and press  to restore the device to defaults according to the prompt.

## Chapter 13 Frequently Asked Questions

### 13.1 Why does the charge indicator flash improperly?

Check the following items.

1. Check whether the device is charged with standard power adapter and the charging temperature is above 0 °C (32 °F).
2. The device is equipped with built-in charging protection module. Charge the device in power off status.

### 13.2 Why is the power indicator off?

Check whether the device is off-battery. Check the indicator after charging the device for 5 minutes.

### 13.3 The image is not clear, how to adjust it?

Adjust the diopter adjustment knob until the image is clear. Refer to section *Adjust Diopter*.

### 13.4 Capturing or recording fails. What's the problem?

Check the following items.

- Whether the device is connected to your PC. Capturing or recording is disabled in this status.
- Whether the storage space is full.
- Whether the device is low-battery.

### 13.5 Why the PC cannot identify the device?

Check the following items.

- Whether the device is connected to your PC with supplied USB cable.
- If you use other USB cables, make sure the cable length is no longer than 1 m.
- Whether the hotspot function is turned on. If so, go to device menu and turn off hotspot.

## Chapter 14 Appendix

### 14.1 Device Command

Scan the following QR code to get device common serial port commands.

Note that the command list contains the commonly used serial port commands for HIKMICRO thermal cameras.



### 14.2 Device Communication Matrix

Scan the following QR code to get device communication matrix.

Note that the matrix contains all communication ports of HIKMICRO thermal cameras.



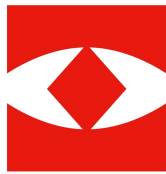

**HIKMICRO**

See the World in a New Way



YouTube: HIKMICRO Outdoor



LinkedIn: HIKMICRO

Facebook: HIKMICRO Outdoor Instagram: hikmicro\_outdoor