

## UHF182X Quick Start Guide

For the full product user guide, please scan QR code or visit [www.oricom.com.au](http://www.oricom.com.au)



### Pack contents

- UHF CB Radio Transceiver
- Heavy Duty Controller Speaker Microphone
- Microphone mounting bracket
- Transceiver mounting bracket
- Pack of supplied mounting screws
- Quick Start Guide

### Please read before installing or operating your Oricom radio

The operation of your UHF radio in Australia and New Zealand is subject to conditions in the following licenses: In Australia, the ACMA Radio communications (Citizen Band Radio Stations) and in New Zealand by MED the General User Radio License for Citizen Band Radio.

When a new narrowband radio receives a transmission from an older wideband radio the speech may sound loud and distorted – simply adjust your radio volume for the best listening performance. When an older wideband radio receives a signal from a new narrowband radio the speech may sound quieter - simply adjust your radio volume for best listening performance. When operating a narrowband radio or Channel 41 - 80 interference is possible from wideband radios transmitting on high power or on adjacent frequency.

The issues described above are not a fault of the radio but a consequence of mixed use of wideband and narrowband radios.



This unit complies with all relevant Australian and New Zealand approval requirements AS/NZS 4365:2011

### Need help? Contact Oricom Support

If you need assistance setting up or using your Oricom product now or in the future, call Oricom Support.

Australia (02) 4574 8888  
[www.oricom.com.au](http://www.oricom.com.au)  
Mon-Fri 8am – 6pm AEST

New Zealand 0800 67 42 66  
Mon-Fri 10am – 8pm NZST

## Controls and Indicators

### Front View of Controller Speaker Microphone

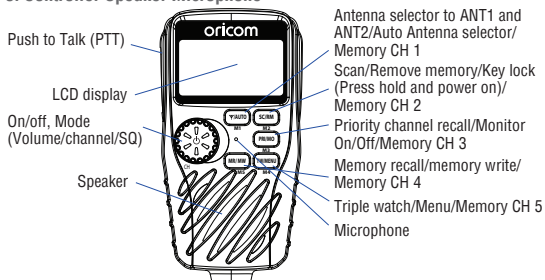

### Rear View of Radio

3.5mm external jack for optional 8 ohm speaker

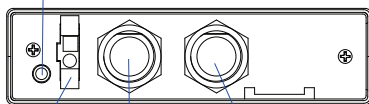

Power supply connection    Antenna Jack 2    Antenna Jack 1

### LCD Icons & Indicators

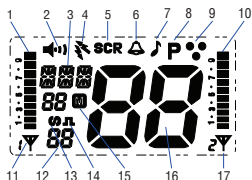

- |                                       |  |
|---------------------------------------|--|
| 1. Signal strength & TX meter of ANT1 | 10. Signal strength & TX meter of ANT2 |
| 2. Monitor                            | 11. Antenna 1 on                       |
| 3. Status display                     | 12. CTCSS or DCS channel display       |
| 4. Duplex on                          | 13. CTCSS on                           |
| 5. Scrambler on                       | 14. DCS on                             |
| 6. Roger BEEP on                      | 15. Memory channel                     |
| 7. Key BEEP on                        | 16. Channel display                    |
| 8. Priority channel                   | 17. Antenna 2 on                       |
| 9. Triple watch on                    |  |

## Warnings and Safety Information



### Potentially Explosive Atmosphere

Turn your radio OFF when in any area with a potentially explosive atmosphere. Sparks in such areas could cause an explosion or fire resulting in injury or even death.

**NOTE:** Areas with potentially explosive atmospheres are often, but not always clearly marked. They include fuelling areas such as below deck on boats; fuel or chemical transfer or storage facilities; areas where the air contains chemicals or particles, such as grain, dust, or metal powders; and any other area where you would normally be advised to turn off your vehicle engine.

### Blasting Caps and Areas

To avoid possible interference with blasting operations, turn your radio OFF near electrical blasting caps or in a "blasting area" or in areas posted: "Turn off two way radios." Obey all signs and instructions.

### Electromagnetic Interference/Compatibility

Nearly every electronic device is susceptible to electromagnetic interference (EMI). To avoid the possibility of electromagnetic interference and/or compatibility conflicts, turn off your radio in any location where posted notices instruct you to do so such as health care facilities.



This radio is designed for operation on a 12 Volt battery system. It should not be connected directly to a 24 Volt system.

When installing your radio in your vehicle, check that during installation you do not damage any wiring or vehicle components that may be hidden around the mounting position.

Ensure the installation does not interfere with the operation of the vehicle and meets all regulatory and safety requirements for accessories fitted to your vehicle.

For optimum performance, your radio needs to be installed correctly. If you are unsure about how to install your radio, we suggest you have your radio professionally installed by a UHF specialist or Auto electrician. When installing the radio, avoid mounting it close to heaters or air conditioners. Never press the PTT button before connecting the antenna to the radio.

## Installation of Your Oricom Radio

### Fitting the Controller Speaker Microphone

The controller speaker microphone uses a 6-pin telephone style plug and socket:

1. Position the microphone plug so the plastic flap faces upward, and insert the plug into the socket until it 'clicks'.
2. Gently press the rubber boot into the hole surrounding the socket so that the slot around the boot fits neatly inside the rim of the entry hole.

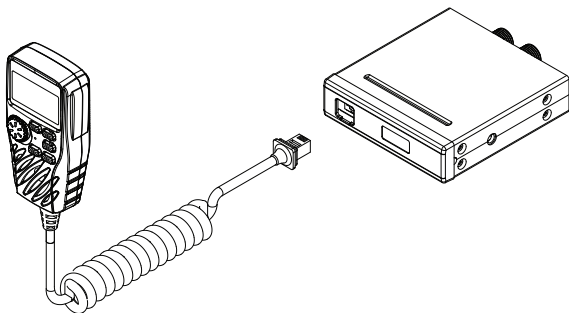

### Disconnecting the Controller Speaker Microphone

It is recommended that the Controller Speaker Microphone be left permanently connected to the radio, but if it must be disconnected, proceed as follows:

1. Lift the rubber boot and the lip of the raised area on the front panel.
2. Ease the rubber boot out of the cable entry hole and slide it along the cable away from the front panel.
3. Identify the plug locking lever, and move the lever towards the plug body. At the same time gently pull the plug from the socket.

### Wiring Methods

There are two possible wiring configurations for connecting to the vehicles power supply.

#### A. Radio stays ON when the ignition is switched OFF

Connect the radio's negative (black) lead to the vehicle chassis, or directly to the battery's negative terminal. Connect the radio's positive (red) lead via the 3 Amp fuse to the battery's positive terminal. Alternatively, the positive lead could be connected at the fuse box at a point that has DC Power continuously available (preferably the battery side of the ignition switch) via the 3 Amp fuse.

#### B. Radio turns OFF with the ignition switch

Connect the radio's negative (black) lead to the vehicle's chassis, or directly to the battery's negative terminal.

The radios positive (red) lead should connect to an accessory point in the vehicle's fuse box via the 3 Amp fuse.

### Antenna information

The antenna (not supplied) is of critical importance to maximise your output power and receiver sensitivity. A poorly installed, inferior quality antenna, or one not designed for the correct frequency band, will give poor performance. You should only purchase an antenna designed for the 477MHz frequency band.

### Antenna installation

To obtain maximum performance from the radio, select a high quality antenna and mount it in a good location.

**Never press the PTT before connecting an antenna to the radio.**

### Optional accessories

SPE85	External speaker If required, you may install an external (8 ohm, Minimum 5W power) speaker fitted with a 3.5mm plug (not supplied). Depending on the installation, it may be necessary to use an external speaker (not supplied) to give improved volume and clarity. This can be plugged into the external speaker (SP) socket on the rear of the unit.
MMM100	Magnetic microphone holder

## Quick Overview of Basic Controls

### Turning on the Power

Press and hold the Channel selector.

At power on, the current applied DC voltage is displayed numerically as shown below.

Special over and under voltage detection circuitry protects the radio and warns of excessive voltage condition by the LCD flashing the 3 backlight colours.

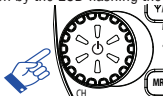

Press and hold



### Setting the Volume

Turn the channel selector clockwise to adjust the sound level for comfortable reception.



### Selecting a channel

Press channel selector once. "CH" will appear on the LCD.

Select the channel by rotating the channel knob.

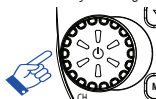

### Setting the Squelch Level

1. Press channel selector 2 times. The current squelch level is displayed.

2. Select the squelch level by rotating the channel knob.

The radio has 16 preset (off to 15) squelch levels, off-Squelch open.

1-Max. sensitivity (Min. squelch)

15-Min. sensitivity (Max/Tight squelch)

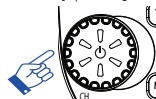

Note :

- \* If a button is not pressed within 5 seconds, the radio will automatically exit the sub display of "VOL" "CH" and "SQ".

### PTT (Push-To-Talk) button

Before transmitting always listen on the channel to make sure it is not being used by another operator.

Pressing the PTT allows audio to be transmitted, by speaking across the front on the controller speaker microphone. TX is indicated by the level bars on the LCD display.

To receive, release the PTT button.

When transmitting, hold the MIC 5cm from your mouth and speaker clearly in normal voice across the front of the mic.

### Factory Reset

If the radio's display locks up or stops functioning properly, you might need to reset your UHF radio.

Caution: this procedure clears all the information you have stored in your UHF radio.

Before you reset your UHF radio, try turning it off and on again.

If your UHF radio is still not functioning correctly you may need to reset the UHF radio.

To reset, press and hold "PRI/MON" button and power on.

"Reset" will appear in the display. The radio will then return to standby mode.

## UHF CB channels and frequencies

Channel		Tx	Rx	Channel		Tx	Rx
		Freq	Freq			Freq	Freq
		MHz	MHz			MHz	MHz
01*		476.4250	476.4250	21		476.9250	476.9250
	41*	-	476.4375		61‡	—	—
02*		476.4500	476.4500	22†		476.9500	476.9500
	42*	-	476.4625		62‡	—	—
03*		476.4750	476.4750	23†		476.9750	476.9750
	43*	-	476.4875		63‡	—	—
04*		476.5000	476.5000	24		477.0000	477.0000
	44*	-	476.5125		64	477.0125	477.0125
05*		476.5250	476.5250	25		477.0250	477.0250
	45*	-	476.5375		65	477.0375	477.0375
06*		476.5500	476.5500	26		477.0500	477.0500
	46*	-	476.5625		66	477.0625	477.0625
07*		476.5750	476.5750	27		477.0750	477.0750
	47*	-	476.5875		67	477.0875	477.0875
08*		476.6000	476.6000	28		477.1000	477.1000
	48*	-	476.6125		68	477.1125	477.1125
9		476.6250	476.6250	29		477.1250	477.1250
	49	476.6375	476.6375		69	477.1375	477.1375
10		476.6500	476.6500	30		477.1500	477.1500
	50	476.6625	476.6625		70	477.1625	477.1625
11		476.6750	476.6750	31*		477.1750	477.1750
	51	476.6875	476.6875		71*	477.1875	-
12		476.7000	476.7000	32*		477.2000	477.2000
	52	476.7125	476.7125		72*	477.2125	-
13		476.7250	476.7250	33*		477.2250	477.2250
	53	476.7375	476.7375		73*	477.2375	-
14		476.7500	476.7500	34*		477.2500	477.2500
	54	476.7625	476.7625		74*	477.2625	-
15		476.7750	476.7750	35*		477.2750	477.2750
	55	476.7875	476.7875		75*	477.2875	-
16		476.8000	476.8000	36*		477.3000	477.3000
	56	476.8125	476.8125		76*	477.3125	-
17		476.8250	476.8250	37*		477.3250	477.3250
	57	476.8375	476.8375		77*	477.3375	-
18		476.8500	476.8500	38*		477.3500	477.3500
	58	476.8625	476.8625		78*	477.3625	-
19		476.8750	476.8750	39		477.3750	477.3750
	59	476.8875	476.8875		79	477.3875	477.3875
20		476.9000	476.9000	40		477.4000	477.4000
	60	476.9125	476.9125		80	477.4125	477.4125

\* The primary use for these channels is repeater operation using 750 kHz offset. Channels 1-8 inclusive are used for mobile reception and channels 31-38 for mobile transmission. Note that additional channels 41-48 and 71-78 are also available for repeater operation to supplement channels 1-8 and 31-38 respectively as approved by the ACMA CBR Class Licence in Australia and the MED GURL in New Zealand. In addition, any designated repeater channel may be used for simplex operation in areas where it is not used for repeater operation.

† Speech telephony shall be inhibited on these channels.

‡ At the time of production Channels 61, 62 and 63 are guard channels and are not available for use. Channel 5 and 35 (paired for Duplex repeaters) are reserved as emergency channels and should be used only in an emergency.

CTCSS and DCS will not operate on these channels.

A list of currently authorised channels can be obtained from the ACMA website in Australia and the MED website in New Zealand. Channel 11 is a calling channel generally used to call others and channel 40 is the customary road vehicle channel.

Once contact is established on the calling channel, both stations should move to another unused "SIMPLEX" channel to allow others to use the calling channel.

Channels 22 and 23 are for Telemetry and Telecommand use, voice communications are not allowed on these channels by law.

Channel 9 and above are the best choices for general use in Simplex mode.

## Express Warranty (Australia)

This Express Warranty is provided by Oricom International Pty Ltd ABN 46 086 116 369, Unit 1, 4 Sovereign Place, South Windsor NSW 2756, herein after referred to as "Oricom".

Oricom products come with guarantees that cannot be excluded under the Australian Consumer Law. You are entitled to a replacement or refund for a major failure and compensation for any other reasonably foreseeable loss or damage. You are also entitled to have the goods repaired or replaced if the goods fail to be of acceptable quality and the failure does not amount to a major failure. Oricom warrants that the product is free from defects in materials or workmanship during the Express Warranty Period. This Express Warranty does not extend to any product from which the serial number has been removed or was purchased outside of Australia.

Nothing in this Express Warranty excludes, restricts or modifies any condition, warranty, guarantee, implied term, right or remedy pursuant to the Australian Consumer Law and which may not be so excluded, restricted or modified. For such conditions, terms, guarantees and warranties that cannot be excluded, restricted or modified, Oricom limits the remedies available to extent permitted in the relevant legislation.

The Express Warranty Period will be 5 years from the date of purchase of the product evidenced by your dated sales receipt. You are required to provide proof of purchase as a condition of receiving Express Warranty services.

You are entitled to a replacement product or repair of the product at our discretion according to the terms and conditions of this document if your product is found to be faulty within the Express Warranty Period. This Express Warranty extends to the original purchaser only and is not transferable.

Products distributed by Oricom are manufactured using new materials or new and used materials equivalent to new in performance and reliability. Spare parts may be new or equivalent to new. Spare parts are warranted to be free from defects in material or workmanship for thirty (30) days or for the remainder of the Express Warranty Period of the Oricom branded product in which they are installed, whichever is longer. During the Express Warranty Period, Oricom will where possible repair and if not replace the faulty product or part thereof. All component parts removed under this Express Warranty become the property of Oricom. In the unlikely event that your Oricom product has a recurring failure, Oricom may always, subject to the Competition and Consumer Act 2010, at its discretion, elect to provide you with a replacement product of its choosing that is at least equivalent to your product in performance.

No change to the conditions of this Express Warranty is valid unless it is made in writing and signed by an authorised representative of Oricom.

Oricom will not be liable under this Express Warranty, and to the extent permitted by law will not be liable for any defect, loss, damage or injury arising out of or in connection with a:

1. Failure by you to adhere to the warnings and follow the instructions set out in this user guide for the proper installation and use of the product;
2. Wilful misconduct or deliberate misuse by you of the product;
3. Any external cause beyond our control, including but not limited to power failure, lightning or over voltage; or
4. Modification to the product or services carried out on the product by anyone other than Oricom or Oricom's authorised service provider.

### How to make a claim under your Express Warranty in Australia

Oricom has a simple warranty process for you to follow:

- Please call or email our Customer Support Team, (02) 4574 8888 or support@oricom.com.au.
- A Customer Support Team member will verify after troubleshooting with you if your product qualifies under warranty. If so, they will give you a Product Return Authorisation number.
- We will then email or fax a Return Authorisation form and a Repair Notice (if necessary), together with instructions on how to return the goods for warranty service.

Please note that if a Customer Support Team member advises that your product does not qualify for return, this warranty does not apply to your product. Products that are authorised to be returned to Oricom in Australia must include all of the following:

- A completed Return Authorisation form
- A copy of your Proof of Purchase (please keep your original copy)
- The faulty product, including all accessories.

Send the approved returns to:

Oricom International Pty Ltd  
Locked Bag 658  
South Windsor NSW 2756 Australia

Please note that this Express Warranty excludes expenses incurred by you in returning any faulty product to us. You must arrange and pay any expenses incurred (including postage, delivery, freight, transportation or insurance of the product) to return the faulty product to us, however, we will arrange delivery of the repaired or replaced faulty product to you.

## Important Information

### Repair Notice

Please be aware that the repair of your goods may result in the loss of any user-generated data (such as stored telephone numbers, text messages and contact information). Please ensure that you have made a copy of any data saved on your goods before sending for repair. Please also be aware that goods presented for repair may be replaced by refurbished goods or parts of the same type rather than being repaired.